

Lee County Conservation Private Lands Services

Food Plots We can plant for you!

Disking	\$35/acre (2-3) passes
Rototilling	\$35/acre (2-3) passes
Cultipacking	\$10/acre
Mowing	\$15-30/acre
Plowing	\$15/acre
Planting	\$20/acre
Broadcasting	\$15/acre + fertilizer
Spraying	\$15/acre + chemical
Chainsaw work	\$50/hour

Conservation Reserve Program(CRP)

Native Grass Plantings	\$30/acre
------------------------	-----------

Equipment Rentals

Equipment	Price	Deposit	
Native Grass/Grain Drill	\$10/acre	\$1000.	
Cultipacker	\$20/day	\$100.	
Wheel Disk	\$20/day	\$100.	
Tree Planter	\$20/day	\$100.	
Wildflower Seeder	\$20/day	\$100.	
Straw Tailgate Mulcher	\$50/day	\$100.	
Live Trap	N/C	\$ 50.	2 week limit
Tree Planter Bar		\$ 25.	5 day limit
Rototiller 5'	\$20/day		
Drip Torch	\$50/day	\$100.	
Backpacks Sprayers	\$5/day	\$ 25.	

See **Specification Requirements** for Equipment. Rentals

To inquire about our services, please contact:

Rick Tebbs, Wildlife Manager @ 319-759-7407 / rtebbs@leecounty.org

Dustin Johnson, Assistant Wildlife Manager @ 319-795-7905 / djohnson@leecounty.org

Field visits are no charge.

PETERSON BLUEBIRD HOUSE

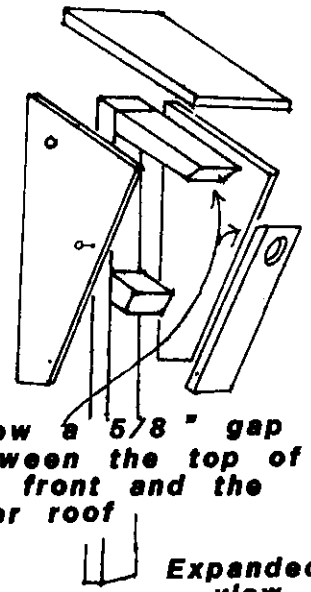
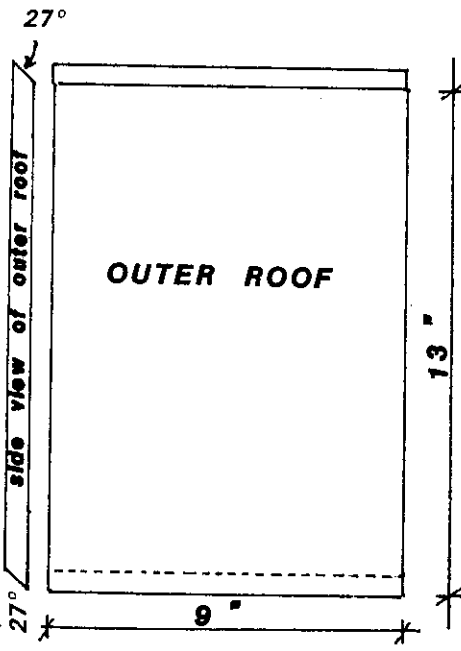
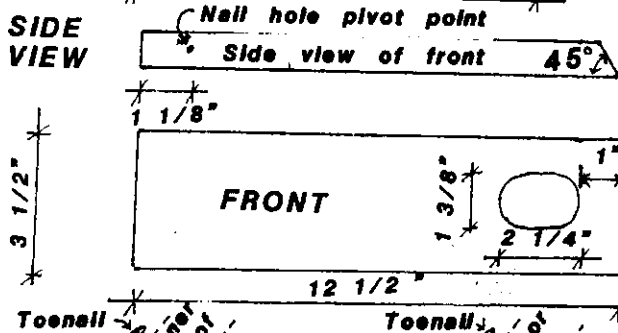
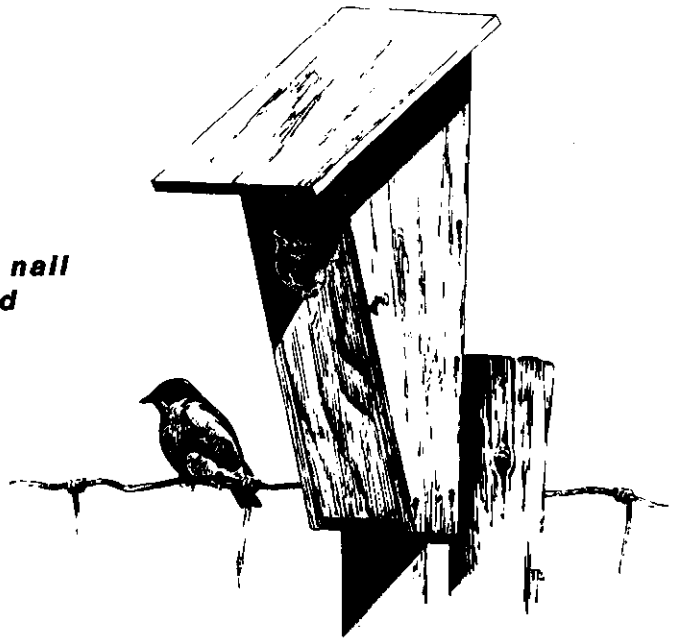
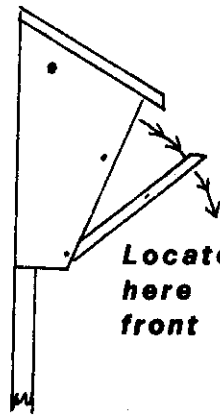
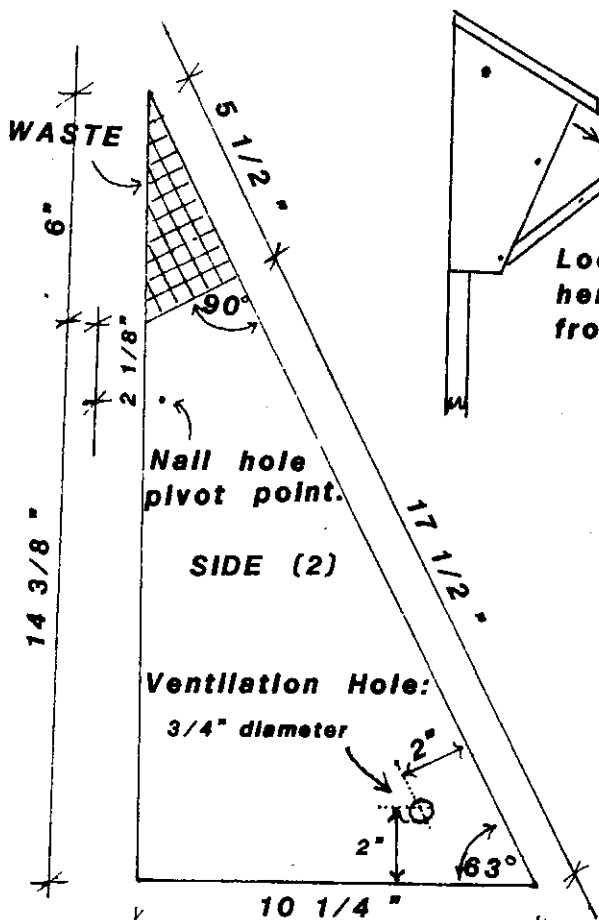

Both of these edges are toe-nailed to back.

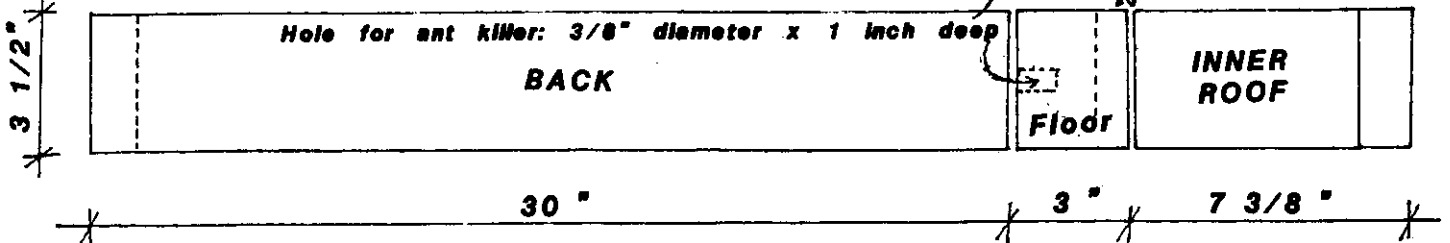



**WOOD DUCK
HOODED MERGANSER
COMMON GOLDENEYE
COMMON MERGANSER
RACCOON
FOX and GRAY SQUIRREL
PILEATED WOODPECKER (?)
NEST BOX**

**HOLE SIZE:
(UP ↑)**

**WOOD DUCK and
HOODED MERGANSER:**
3" high & 4" wide oval

COMMON GOLDENEYE:
3 1/2" high and 4 1/2" wide oval

COMMON MERGANSER and RACCOON:
5" high and 9" wide oval

FOX and GRAY SQUIRREL:
3" diameter round

PILEATED WOODPECKER
4" diameter round

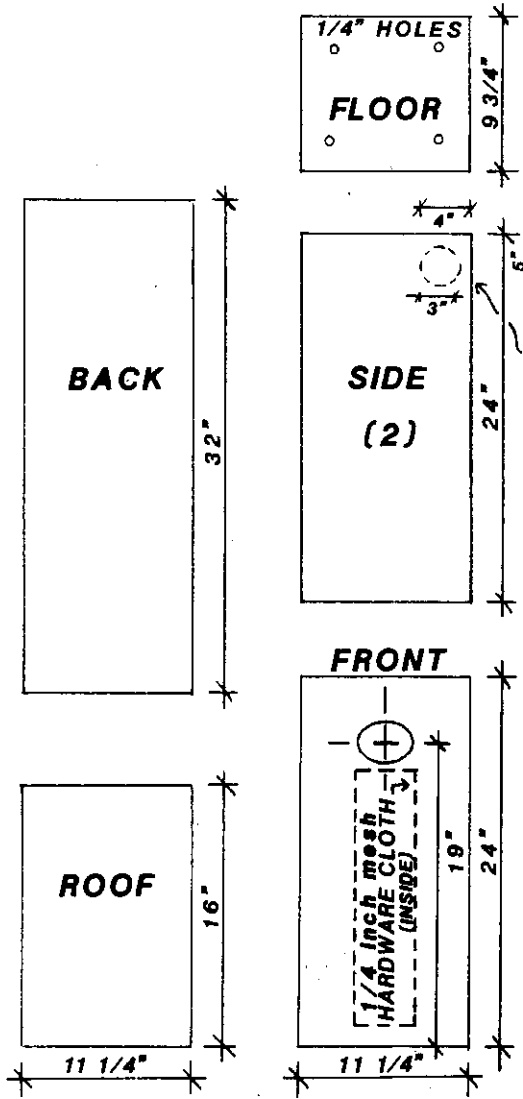

Optional site for squirrel box entrance

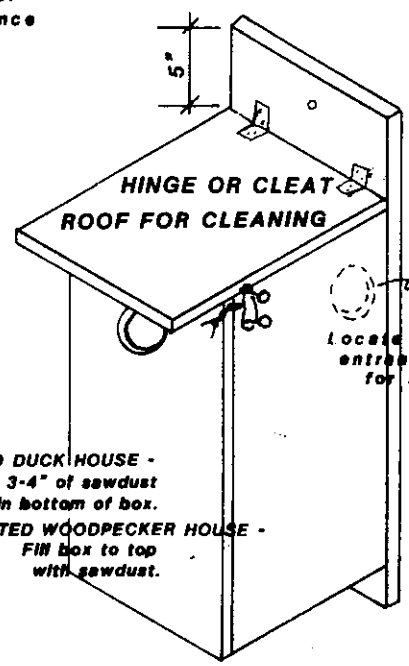

FOR WOOD DUCK HOUSE -
Place 3-4" of sawdust in bottom of box.

FOR PILEATED WOODPECKER HOUSE -
Fit box to top with sawdust.

LUMBER:

ONE 1" x 12" x 12' 0"

NOTE: PILEATED WOODPECKER BOX SHOULD BE CONSTRUCTED FROM ONE 2" x 12" x 12' 0" CEDAR, AND FLOOR MUST BE 8 1/4" LONG INSTEAD OF 9 3/4" FOR USE OF 1 1/2" THICK LUMBER.

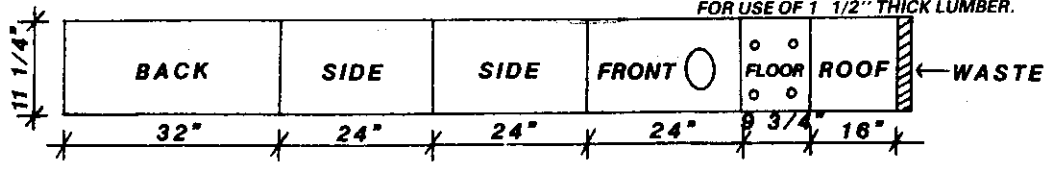

BAT HOUSE

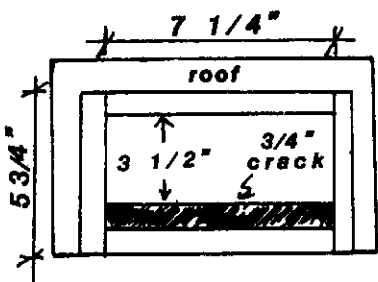

BOTTOM VIEW

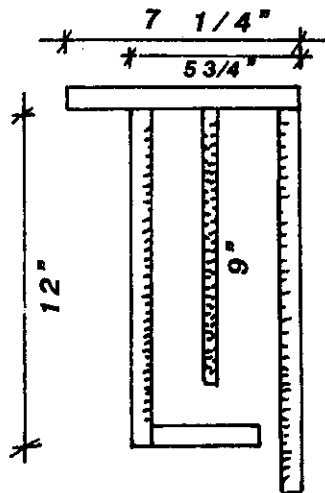

**SIDE VIEW
(cut-away)**

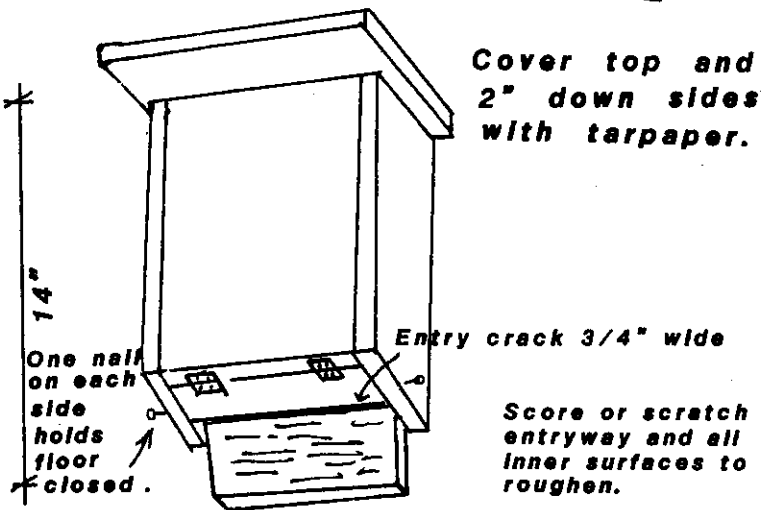

**FRONT VIEW
as mounted on building**

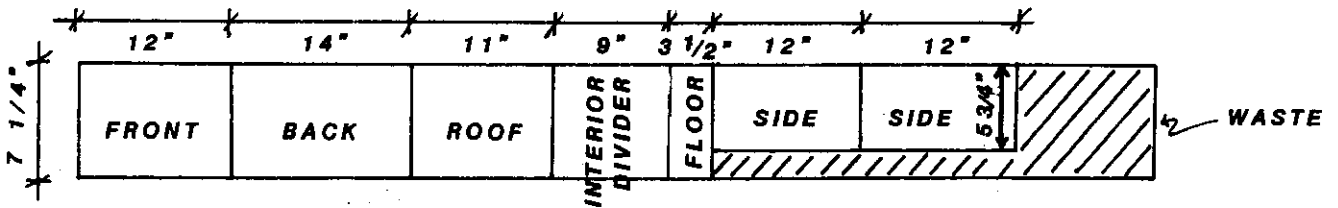

LUMBER: One 1"x8"x 8'0"

**LOOK FOR THE LOON ON YOUR MINNESOTA TAX FORMS!
THE LOON MARKS THE LINE WHERE YOU CAN HELP WILDLIFE
BY DONATING TO THE NONGAME WILDLIFE CHECKOFF**